

MODEL #SN713-4A

1/2" BALL NOSE NOZZLE (.750 DIA)
EXTENDED LENGTH

MODEL #SN713-4A-SPC

1/2" BALL NOSE NOZZLE (.750 DIA)
EXTENDED LENGTH
(BODY AND PIN ARE 3/8" SHORTER THAN 4A)

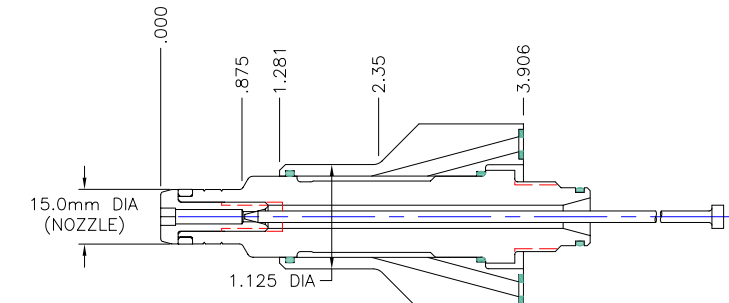

MODEL #SN713-12A

DIVING NOZZLE SHORT LENGTH (15mm DIA)

MODEL #SN713-12A-SPC

DIVING NOZZLE SHORT LENGTH (15mm DIA)
(BODY AND PIN ARE 3/8" SHORTER THAN 12A)

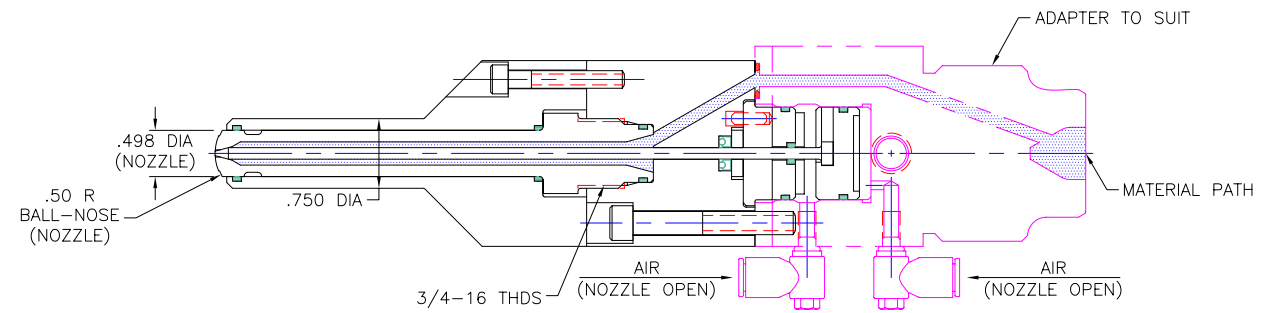

MODEL #SN713-1A

1/2" BALL NOSE NOZZLE (.750 DIA)
STANDARD LENGTH

MODEL #SN713-1A-SPC

1/2" BALL NOSE NOZZLE (.750 DIA)
STANDARD LENGTH
(BODY AND PIN ARE 3/8" SHORTER THAN 1A)

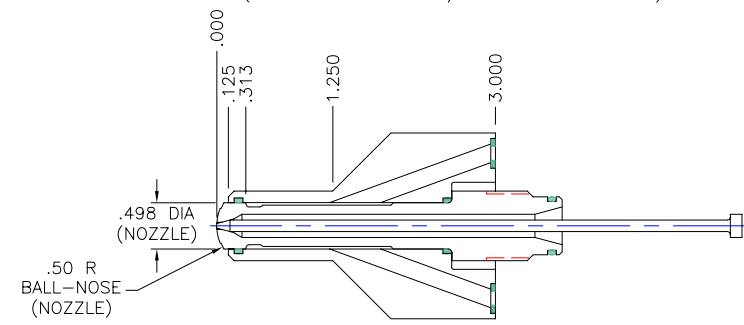

MODEL #SN713-6A

1/2" BALL NOSE NOZZLE (.750 DIA)
SHORT LENGTH

MODEL #SN713-6A-SPC

1/2" BALL NOSE NOZZLE (.750 DIA)
SHORT LENGTH
(BODY AND PIN ARE 3/8" SHORTER THAN 6A)

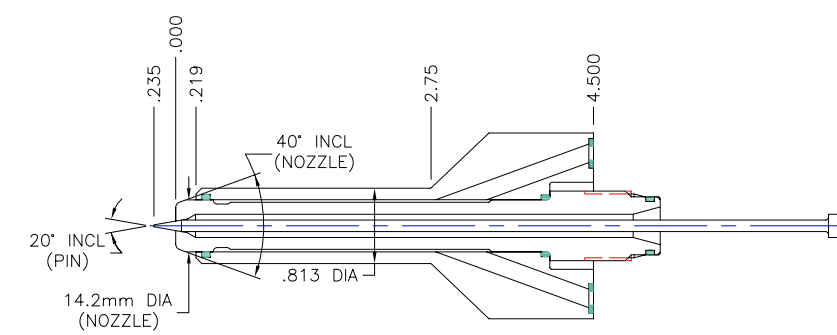

MODEL #SN713-13A

DIRECT CAVITY SHUTOFF NOZZLE STYLE (14.2mm DIA)

MODEL #SN713-13A-SPC

DIRECT CAVITY SHUTOFF NOZZLE STYLE (14.2mm DIA)
(BODY AND PIN ARE 3/8" SHORTER THAN 13A)

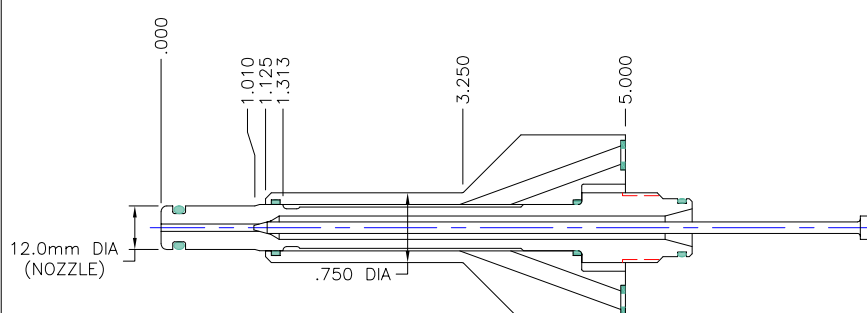

MODEL #SN713-2A

DIVING NOZZLE (12mm DIA)

MODEL #SN713-2A-SPC

DIVING NOZZLE (12mm DIA)
(BODY AND PIN ARE 3/8" SHORTER THAN 2A)

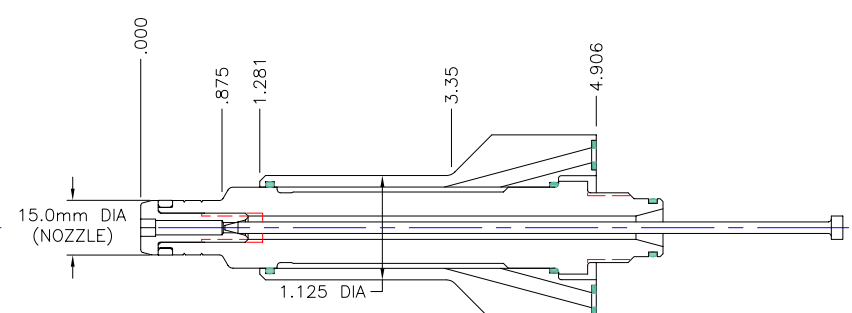

MODEL #SN713-8A

DIVING NOZZLE (15mm DIA)

MODEL #SN713-8A-SPC

DIVING NOZZLE (15mm DIA)
(BODY AND PIN ARE 3/8" SHORTER THAN 8A)

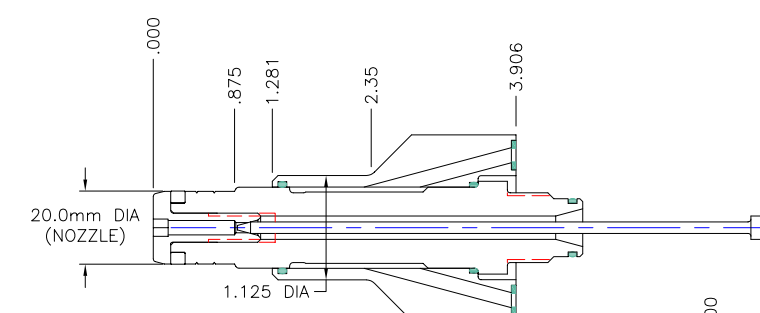

MODEL #SN713-14A

DIVING NOZZLE SHORT LENGTH (20mm DIA)

MODEL #SN713-14A-SPC

DIVING NOZZLE SHORT LENGTH (20mm DIA)
(BODY AND PIN 3/8" SHORTER THAN 9A)

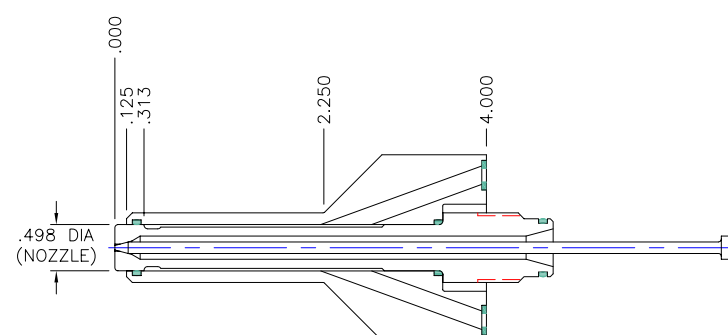

MODEL #SN713-3A

FLAT-TIP NOZZLE (.750 DIA)

MODEL #SN713-3A-SPC

FLAT-TIP NOZZLE (.750 DIA)
(BODY AND PIN ARE 3/8" SHORTER THAN 3A)

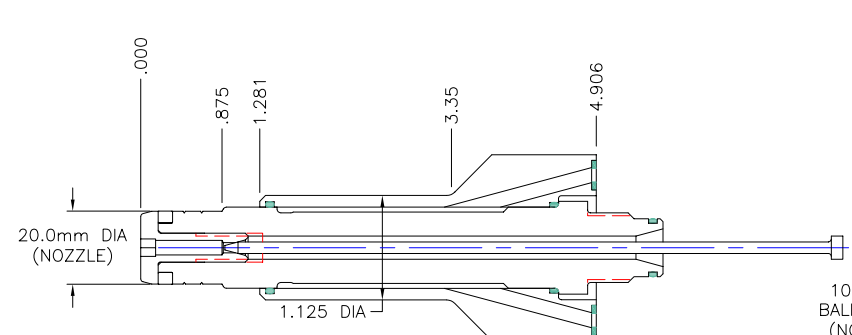

MODEL #SN713-9A

DIVING NOZZLE (20mm DIA)

MODEL #SN713-9A-SPC

DIVING NOZZLE (20mm DIA)
(BODY AND PIN 3/8" SHORTER THAN 9A)

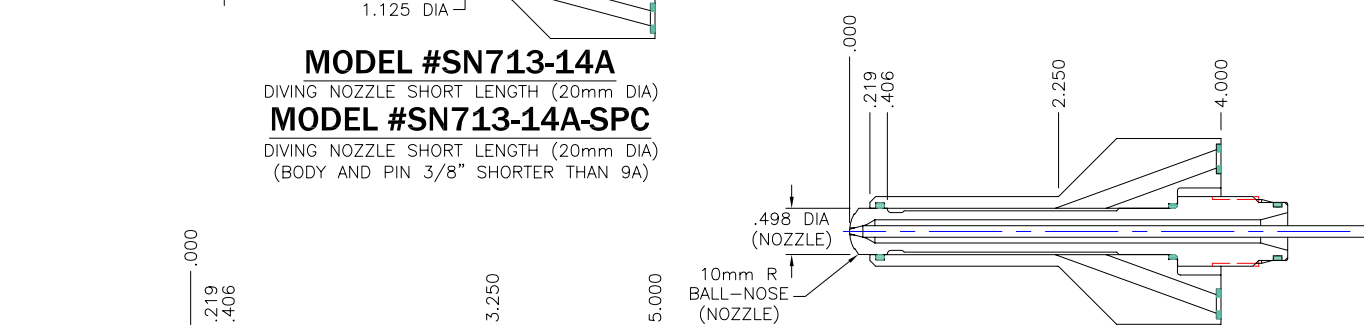

MODEL #SN713-15A

10mm BALL NOSE NOZZLE (.750 DIA)

MODEL #SN713-15A-SPC

10mm BALL NOSE NOZZLE (.750 DIA)
(BODY AND PIN ARE 3/8" SHORTER THAN 15A)

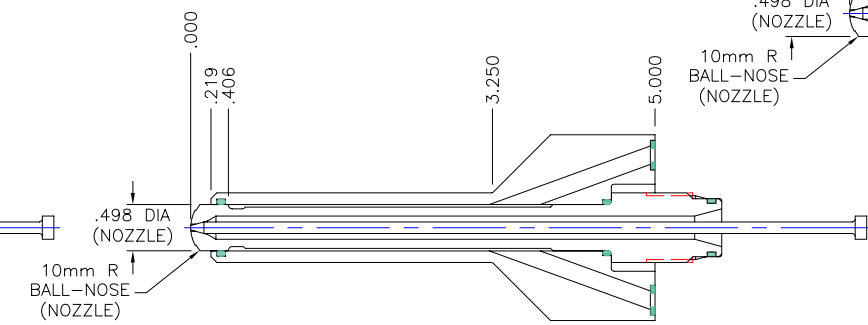

MODEL #SN713-16A

10mm BALL NOSE NOZZLE (.750 DIA)
EXTENDED LENGTH

MODEL #SN713-16A-SPC

10mm BALL NOSE NOZZLE (.750 DIA)
EXTENDED LENGTH
(BODY AND PIN ARE 3/8" SHORTER THAN 15A)

VS: 2012.03.29

FLUID Automation, Inc. WIXOM, MI.			
DATE: 7-22-03	DES: J.M.	CHK'D: F.A.	SCALE: FULL
DESCRIPTION:		F.A.I. STANDARD MODEL #SN713 DUAL ACTING INJECTION NOZZLE	